



## SMART SOLUTIONS FOR DISPERSIONS CHARACTERISATION

[www.formulation.com](http://www.formulation.com)

STABILITY & SIZE

MICRORHEOLOGY

RHEOLOGY ON CHIP



Australia  
Austria  
Argentina  
Belgium  
Brazil  
Canada  
China  
Columbia  
Costa Rica  
Cuba

Czech Republic  
Denmark  
Finland  
France  
Germany  
Greece  
Hungary  
Iran  
Ireland  
Israel

Italy  
India  
Japan  
Kingdom of Saudi  
Arabia  
Luxembourg  
Malaysia  
Mexico  
Netherland  
New Zealand

Norway  
Poland  
Portugal  
Qatar  
Russia  
Singapore  
South Africa  
South Korea  
Spain  
Sweden

Switzerland  
Taiwan  
Thailand  
Turkey  
UK  
Ukraine  
USA  
United Arab Emirates  
Venezuela

# SMART SOLUTIONS FOR DISPERSIONS CHARACTERISATION

FORMULATION spirit is summarized in 3 words:  
**Pioneer, Dynamic, Worldwide**

For 20 years, Formulation's wish is to provide formulators with valuable information to characterize dispersions in terms of physical stability & viscoelastic properties. Because of the complex nature and fragile equilibrium of emulsions & suspensions, our aim is to offer analytical solutions which analyse the sample in its native state. Our instruments are dedicated to R&D scientists, researchers and technicians who want to develop, optimize, manufacture and control high quality products.

### PIONEER

In 1994, Formulation was a pioneer in the field of physical stability by creating the TURBISCAN, the first instrument to analyse concentrated dispersions without dilution, thanks to the Static Multiple Light Scattering.  
Since 2006, Formulation is the first and only company to use the Diffusing Wave Spectroscopy to analyse film formation, rheology or even to perform thermal analysis with the RHEOLASER range.  
In 2016, Formulation innovates again with the FLUIDICAM, an optical rheometer, based on microfluidics.

### DYNAMIC

Today Formulation is the leading company in the the characterization of concentrated dispersions. We keep on innovating to offer you the best solutions for a better analysis and understanding of your formulas, with highly skilled employees in chemistry, physics, optics and mechanics...  
Our partnerships with Research Institutes and Universities, and our membership in scientific organizations (ISO, ACS, SCF..) allow us to offer the highest level of expertise.

### WORLDWIDE

Formulation is represented in more than 50 countries all over the world thanks to an efficient and well-trained distributor's network and a subsidiary in the USA.  
Supporting our worldwide partners is one of our top priorities in order to be close to our users.

### Some key numbers:

- More than 2000 R&D labs equipped
- More than 2000 scientific publications
- More than 700 patents using our instruments
- Represented in more than 50 countries worldwide

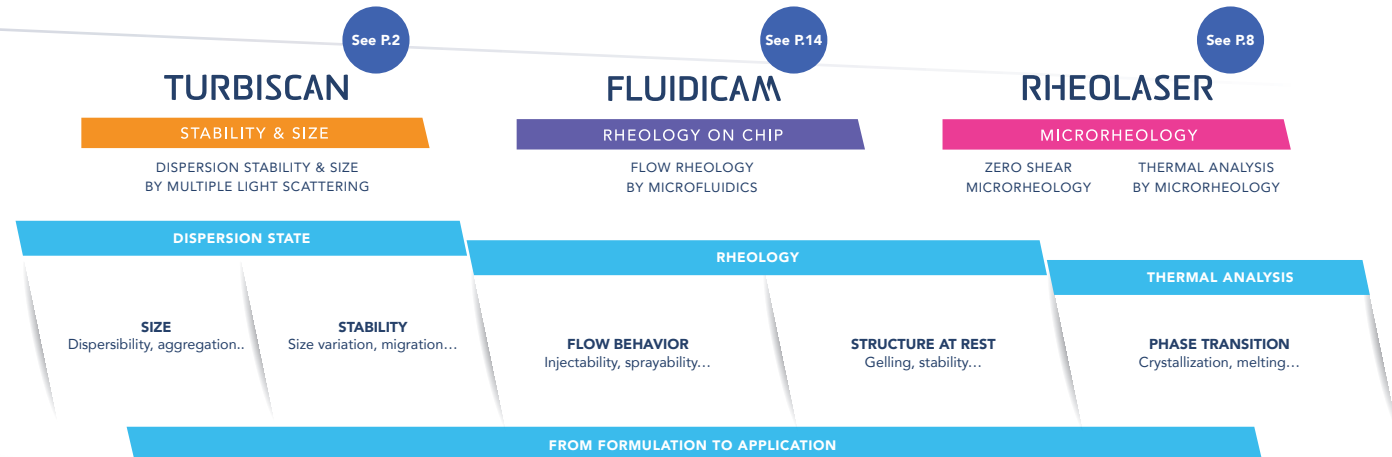



STABILITY & SIZE

# MASTER YOUR DISPERSIONS STABILITY

# STATIC MULTIPLE LIGHT SCATTERING

## OPTICAL MEASUREMENT OF PARTICLES CONCENTRATIONS AND SIZE



### MLS SOLUTIONS

The Turbiscan works on Multiple Light Scattering in both Transmission (T) and Backscattering (BS) mode, in order to analyse low and high concentration dispersions.

- T & BS signals depend on particle size and concentration:  
 $BS \& T = f(d/\varphi)$
- Size range: 10 nm to 1 mm ;
  - Concentration range: 0.0001 to 95% v/v ;

### SCAN CONFIGURATION

The Turbiscan acquires T & BS every 20 microns along the sample height, thanks to a patented scanning reading head.

Scans are repeated during sample ageing time to detect any variation of the signal due to a destabilisation, such as particle migration and/or particle size variation.

### DATA REPORTING

The software provides multi-level data treatment for both experts and non-experts.

- The Turbiscan Stability Index (TSI) is a one-click feature providing the key number depending on the global stability of the sample. It is a quick and easy way to characterise the sample, and enables the user to compare & rank various formulations.
- Kinetics computation based on the raw signal allows to identify and quantify in detail the phenomena taking place in the samples, depending on size and concentration variations.
- The user can compute the evolution of the mean particles diameter or concentration during the ageing of the product in any part of the sample. This enables to control the dispersibility of particles, and monitor aggregation, in native dispersions, as recommended by ISO TR 13097

### TURBISCAN IS THE REFERENCE FOR STABILITY ANALYSIS

Turbiscan is used world-wide to detect at an early stage all kinds of destabilisation such as coalescence, flocculation, creaming, sedimentation, etc... Various products such as emulsions, suspensions or foams can be studied from low to high concentrations without any sample preparation or dilution.

Stability kinetics and index are measured for an efficient sample analysis and comparison.

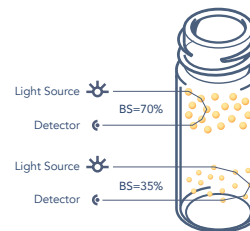
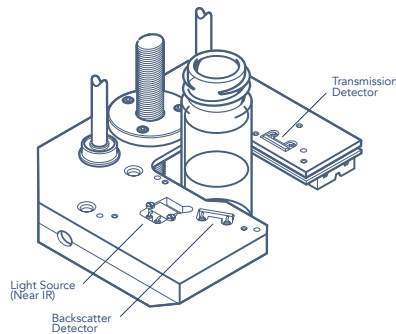

### STABILITY

No variation of BS and T

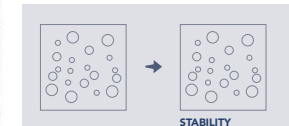
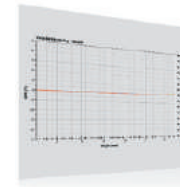

### PARTICLE MIGRATION

Local peaks of variation of BS or T

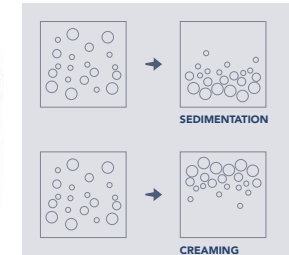
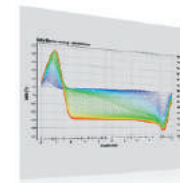

### PARTICLE SIZE VARIATION

Global variation of BS or T on the whole height

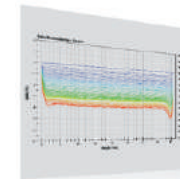

STABILITY &amp; SIZE



1



No

Also available in  
OIL SERIES  
version



## TURBISCAN CLASSIC 2

STABILITY &amp; SIZE

### Basics of the technology for short-term stability, and its Oil Series version

Turbiscan™ Classic helps to optimise the pre-formulation work by giving a quick insight into the instability phenomena. This updated version of the first Turbiscan is still a success after 20 years.

- Identification and quantification of instability
- Quick and reliable
- Portable and robust
- OIL SERIES: compliant with ASTM D-7061 for Heavy Fuel Oil analysis



1



RT-60°C



## TURBISCAN LAB

STABILITY &amp; SIZE

### The reference stability analyser

Accelerate and document ageing tests for a fast and deep understanding of destabilisation mechanisms (creaming, sedimentation, flocculation, coalescence). Turbiscan™ LAB can be used in both R&D labs for formulation development and QC labs to control the stability of raw materials and final products.

- Identification and quantification of instability
- Long-term stability analysis
- From RT to 60°C



## Turbiscan Stability Index

Based directly on the raw data, this unique number takes all destabilisation into account, providing you with a powerful tool to rank & compare all your formulas in just one-click.

**Determining shelf-life of your products has never been easier!**



6



4-80°C



## TURBISCAN TOWER

STABILITY &amp; SIZE

### The new reference, 6 times better

The brand new spearhead of the Turbiscan range to fully characterise the stability of concentrated dispersions (emulsions, suspensions, foams). Discover its new patented mechanical design, for an even better performance.

- Up to 6 samples at a time
- From 4°C to 80°C
- Higher vertical resolution: acquisitions every 20 microns.



54



RT-60°C



## TURBISCAN AGS

STABILITY &amp; SIZE

### High throughput stability analyser

High throughput screening is more and more useful to shorten the formulations time-to-market. Turbiscan™ AGS integrates the Turbiscan™ LAB, a robot, a storage station and a smart software for automatic sample handling and treatment. This concept enables an automated management of ageing tests from sample storage at different temperatures to shelf-life determination.

- Up to 54 samples
- 3 storage racks from RT to 60°C
- Traceability, reproducibility, objectivity

**HOME & PERSONAL CARE**

- Emulsions, lotions, creams: Decrease significantly time of stability analyses (up to 200 times).
- Sun creams: Difficult to analyze by visual observation, Turbiscan detects and quantifies the destabilization of the different particles.
- Make-up: Detects sedimentation of foundation, nail varnish, lipsticks.
- Foams: Easy way to follow the bubble ripening and the drainage.
- Shampoos: Stability of pearlescent agent.

**FOOD**

- Dairy products: Quantify and detect characteristic destabilization of milk based products : particle size variation, creaming of fat droplets, sedimentation of calcium or chocolate particles.
- Flavor emulsions: no dilution required to detect droplet size variation.
- Soft drinks: ring formation, color change, pulp sedimentation.
- Desserts: Detect destabilization phenomena of cream, dessert foam, ice cream.
- Raw materials: monitor the efficiency of stabilizers, thickeners...

**PHARMACEUTICALS**

- Vaccines: Kinetic of particles aggregation and sedimentation (proteins, metal oxides...).
- Skin lotions and creams: Detection of coalescence and creaming up to 200 times faster than visual test.
- Ophthalmic suspensions: Study of the re-dispersion of active ingredient after storage.
- Inhalers (pMDI): Study of particles aggregation & sedimentation in pressurized measurement cells.

**OIL & PETROLEUM**

- Stability of Fuel oils: Analyze stability reserve in 15 minutes thanks to the ASTM D-7061.
- Stability of Crude oils: Analyse aggregation and sedimentation kinetic of asphaltenes.
- Efficiency of additives for demulsification: Qualify the best additive in order to de-emulsify water-in-oil emulsions.
- Efficiency of dispersants for asphaltenes: Measure asphaltene aggregation kinetics versus dispersant amount.
- Quantification of amount of additive: Save costs by using just needed quantity of additive.
- Stability of drilling fluids: Detect and quantify destabilization phenomena.

**PAINT & INK**

- Sedimentation: Analyse the settling rate in suspension.
- Aggregation: Monitor the size variation in the suspension.
- Packing: Analyse the formation of a cake at the bottom of the sample.
- Redispersibility: Be sure that shaking or stirring gives your sample its initial properties back.

**ELECTRONICS**

- Slurries (CMP...): easily check the homogeneity & stability of slurries before next steps of the process.
- Electronic components (MLCC...): quality of the dispersion state during the production of Multi-Layer Ceramic Capacitors.
- Display (LCD, LED, e-Paper, QD...): influence of additives on dispersion stability.
- Energy (Solar cells, Fuel cells, Secondary battery, DSSC...): quality and homogeneity of the inks coated to the solar cells.
- Printed electronics (Conductive inks, RFID, Flexible displays...): check the size variation of nano particles in electronic inks.

**BENEFITS****NON-CONTACT MEASUREMENT:  
TRUE STABILITY**

Measurement is done without any mechanical or external stress, and without any dilution, thus allowing the monitoring of the true ageing of the product.

**OPTICAL AND THERMAL  
ACCELERATION**

Thanks to the high optical resolution (up to 100x faster) and the possibility of high storage temperatures (up to 200x faster), stability tests have never been shorter.

**IDENTIFICATION AND  
QUANTIFICATION**

Easily identify and quantify the destabilisation phenomena in the samples, in order to rank and compare all your formulas.

**CONCENTRATED MEDIA**

Access to real information directly in diluted or concentrated dispersions (0 to 95% v/v), without any dilution nor sample preparation, over a wide range of sizes (10 nm to 1 mm).



# TURBISOFT

Your dispersions stability at a glance !

ISO  
TR 13097  
COMPLIANT

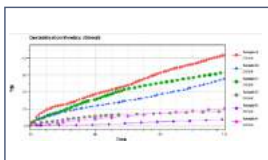

## TURBISCAN STABILITY INDEX

From nascent destabilisations to complete phase separations, just 1-click to rank and compare all your samples!

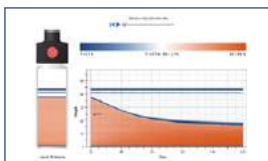

## DESTABILISATION MOVIES

Be sure to understand what happens by replaying the destabilisation movie with a very visual animation.

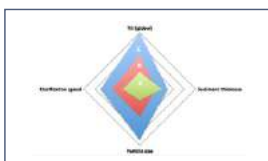

## RADAR CHARTS

Easily monitor several parameters in a same graph, and always be sure of choosing the best sample, according to YOUR criteria!



## SIZE AND DISPERSIBILITY

Characterise the dispersibility of your particles in a native dispersion, by measuring their mean diameter (detect flocks or aggregates).

A grayscale micrograph of several cells, likely yeast or bacteria, with bright blue fluorescent spots distributed within them. The spots are most prominent in the top two cells. A pink horizontal bar is positioned above the main title.

MICRORHEOLOGY

# EXPLORE RHEOLOGY AT THE NANO-SCALE

# DIFFUSING WAVE SPECTROSCOPY

## OPTICAL MEASUREMENT OF PARTICLES MOBILITY



### DWS SOLUTIONS

Our microrheology analysers use MS-DWS (Multi-Speckle Diffusing Wave Spectroscopy) principle of measurement. It corresponds to Dynamic Light Scattering extended to concentrated dispersions. It measures the particles motion, which depends on the structure of the sample. This technique consists in sending a coherent laser beam into the sample, leading to interfering waves, which create a Speckle pattern captured with a video camera detector. The variations of this speckle image are directly linked, through a correlation function, to the particles motion, their speed and the distance they explore.

### MICRORHEOLOGY: THE BEST SOLUTION FOR VISCOELASTICITY ANALYSIS AT REST

Microrheology enables measurement of the evolution of the structure, viscosity and elasticity, in bulk samples or in films. The measurement is performed at rest, as no mechanical stress is applied to the sample. This technique allows monitoring of sample evolution : gelation, ageing, stability, phase transitions, but also drying of coatings.

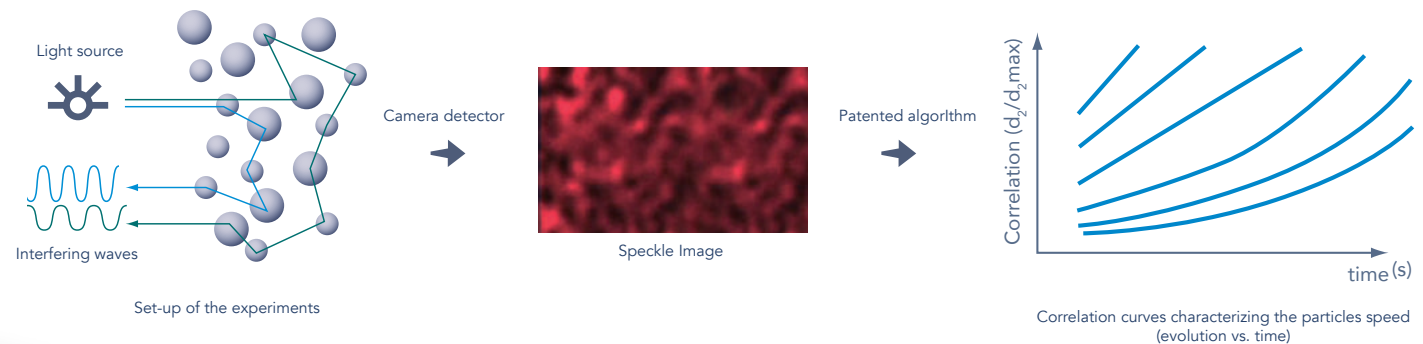

### ONE TECHNIQUE, THREE APPLICATIONS

Based on this technique, it is therefore possible to characterize samples with different forms, and for different properties:

- In a bulk, by monitoring the Brownian motion of the particles, MS-DWS will give access to the viscoelastic properties of a sample, at rest, without any external stress. This enables to measure viscosity and elasticity as a function of time or any other parameter (temperature, pH, concentration). That is the purpose of **Rheolaser MASTER**.

- In a coating or a thin layer of sample, by monitoring the average speed of the particles, MS-DWS will give access to the characteristic times of a drying or a curing. This application is possible through the use of the **Rheolaser COATING**.

- As a function of temperature, MS-DWS will enable to monitor the phase transitions, or the polymorphic transitions in a product of any form (liquid, solid, gel), making it possible to perform a thermal analysis experiment on a macroscopic sample, even if heterogeneous or fragile. That is performed with the **Rheolaser CRYSTAL**.

## PHASE TRANSITIONS & CRYSTALLIZATION



### FOOD

- Predict the blooming of a chocolate ;
- Control the crystal forms in a fatty product (margarines, spreads, ...)
- Observe crystallization in honey or other natural products ;



### HOME & PERSONAL CARE

- Crystallization of lipsticks or deodorants ;
- Improving sensorial properties by optimizing melting temperature



### RAW MATERIALS & OTHERS

- Exudation of a fat raw material ;
- Determine melting temperatures ;
- Ageing simulation by temperature cycles ;
- Monitor the effect of a process (history of a sample) ;

## FILM FORMATION ANALYSIS



### PAINT & INKS

- Determine accurately the open-time ;
- Control the dust-free time, touch-free time, dry-hard time, etc...
- Monitor effect of a thickener or additive ;
- Architectural or specialty paints ;
- Gravure inks, paper inks, e-inks, etc... ;



### HOME & PERSONAL CARE

- Drying of nail varnishes ;
- Evolution of a mascara ;



### OTHER COATINGS

- UV-curing of specialty products ;
- Control the drying of glues ;

## VISCOELASTIC ANALYSIS IN BULK



### FOOD

- Monitor gelation of yogurts versus time, temperature or pH ;
- Characterize the texture of salad dressing, creams, mayonnaise, etc



### HOME & PERSONAL CARE

- Determine ideal concentration of softeners to reduce packaging size ;
- Control the texture of cosmetic creams or toothpastes ;
- Analyse the rheology and stability of shampoos ;



### PHARMACEUTICALS

- Adapt thickener concentration for cough syrups.
- Control the gel properties of eye-drops.
- Characterise the rate of delivery of polymer-based drugs.



### PAINT & INK

- Control the texture and behaviour of non-drip paints.
- Monitor the speed of recovery after application of the paint (brushing, pumping...).



### MATERIALS

- Determine the pot-life of composite components.
- Monitor effect of additives on cement setting.



### & MANY OTHERS

- Measure the rheology of polymer dispersions for Oil Recovery.
- Characterise the behaviour of slurries, lubricants, etc...

## BENEFITS

### NON CONTACT MEASUREMENT

Measurement is performed without any external stress. It allows the analysis of fragile materials (weak gels, creams, etc...) without sample modification nor destruction.

### VISCOELASTIC PROPERTIES VS. TIME OR TEMPERATURE

- Gelation process ;
- Structure recovery ;
- Drying process ;
- Long-term stability ;
- Polymorphic or phase transitions ;

### EASY SAMPLE HANDLING

- No evaporation or drying (MASTER)
- Open environment (COATING)
- Large sample (CRYSTAL)
- No geometry configuration ;
- Disposable measurement cells ;

## RHEOLASER CRYSTAL: THERMAL ANALYSIS BY MICRORHEOLOGY

Rheolaser Crystal enables to monitor microstructure evolution in heterogeneous products by combining a non-invasive measurement, thanks to the DWS, with an accurate temperature ramp and sufficiently large sample volume to overcome problems of heterogeneities and sensitivity to sampling. This enables to measure finished products, such as food, cosmetics or pharmaceuticals, and identify transition temperatures of proteins, polymers, waxes or any fatty compounds.

### MAIN ADVANTAGES

- Any sample size or form, enabling analysis of fragile and heterogeneous products
- Non intrusive measurement & direct and large sampling
- Fast & accurate temperature control

### KEY PARAMETERS

Correlation curves can be processed to obtain the Micro-Dynamics (Hz) versus temperature (or time). These values (typically the speed of change in the microstructure) will give characteristic peaks when the product shows a microstructural evolution, such as a phase transition or any other physical event. Based on these parameters, it is then possible to determine accurately transition temperatures, range of transitions, and polydispersity in the sample structure.

### ASSETS OF THERMAL ANALYSIS BY MICRORHEOLOGY

Thanks to this instrument, the analysis of polymorphic transitions (from a crystal form to another, or from a phase to another) is possible on a macroscopic piece of sample. Compared to conventional methods, that means being able to work on heterogeneous products, and also, not risking to damage the product's structure during sampling.



## RHEOLASER CRYSTAL

MICRORHEOLOGY

### Take a deeper look at your samples microstructure

A brand new instrument dedicated to monitoring phase transitions, crystallization or melting. This innovative concept offers very accurate results, together with the possibility to work directly on macroscopic end-products.

- Any sample size or form
- From 4 to 90°C, with a 0.1 to 25°C/min ramp speed
- Easy data treatment to identify transition temperatures and polydispersity.



## RHEOLASER COATING

MICRORHEOLOGY

### Optical film formation analyser

Determine accurately the drying or curing times and mechanisms of any coating or film-forming product.

- **1 to 4 simultaneous measurements**
- **Non-invasive technology**
- **Understanding of the drying mechanisms**

### RHEOLASER COATING: CONTACT-FREE FILM FORMATION ANALYSER

The very first commercial instrument based on MS-DWS technology, the Rheolaser COATING enables monitoring of microstructure changes during the film formation process. It identifies the drying mechanisms and characteristic drying times on any kind of substrate. It works on any film-forming product or coating, such as inks, paints, varnishes, resins, binders, cosmetic films...

#### MAIN ADVANTAGES

- Non-intrusive method
- Microstructure analysis
- Measurement on any kind of substrate

#### FLUIDITY FACTOR: A UNIQUE PARAMETER TO MONITOR FILM FORMATION

Thanks to the unique and patented A.S.I.I (Adaptive Speckle Image Interferometry) processing, correlation curves can be used to compute the so-called "Fluidity Factor", and its evolution versus time, which is displayed in real-time, providing a wide range of information such as:

- **Drying time** (open time, touch-dry time, dry-hard time, ...)
- **Curing time**
- **Microstructure change** (particle packing, particle deformation, curing...)

#### A VERSATILE DEVICE

Rheolaser COATING has been designed as an open configuration to run experiments with automatic coater and/or vacuum bed. It works on any kind of substrate: metal, glass, plastic; wood, concrete, paper, and records temperature and humidity all the time for a perfect traceability...

## RHEOLASER MASTER: EXPLORE RHEOLOGY AT REST

The Rheolaser MASTER is dedicated to formulators interested in the end-use properties of their products, such as gelation, stress recovery, shape stability, long-term stability & many others... It is specifically designed for monitoring viscoelastic evolutions such as SOL-GEL transition (gelation), viscoelastic changes during ageing or recovery, on the very same sample.

### MAIN ADVANTAGES

- Measurement AT REST (zero-shear), non-intrusive & non-destructive.
- One-click experiment & results (no parameters needed).
- Kinetic or ageing analysis on the very same sample.
- Hazardous samples can be analyzed in a closed glass cell.

### KEY PARAMETERS

#### MEAN SQUARE DISPLACEMENT (MSD)

The MSD in a purely viscous fluid grows linearly with time, while in a viscoelastic fluid, particles are limited in their displacement, as they are trapped by the microstructure network, leading to a plateau in the MSD curve.

SOLID-LIQUID BALANCE (SLB), ratio between the solid-like and the liquid-like behavior of the studied sample.

ELASTICITY INDEX (EI), elasticity strength in the studied sample.

MACROSCOPIC VISCOSITY INDEX (MVI), quantify and compare the macroscopic viscosity at zero-shear.

## SOL-GEL ANALYSIS

When a gel is forming (sol-gel transition), the sample's rheology evolves from a purely viscous liquid-like state to a solid-like state.

Acquisition of particles MSD curves as a function of the gel variable (time, temperature, concentration, pH...) enables the monitoring of the sol-gel process. A rescaling data process, known in rheology as "Time Cure Superposition" may then be applied to determine with high precision gel point and gel strength.

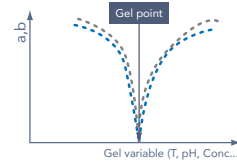
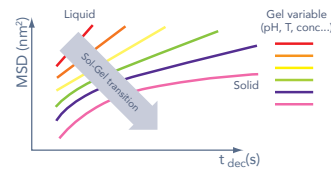

## RHEOLASER MASTER

MICRORHEOLOGY

### A precious tool to characterize viscoelasticity and its evolution

The state-of-the-art device, dedicated to monitoring evolution of the rheological properties, such as viscoelasticity change versus ageing time, or sol-gel transition with high accuracy thanks to the Time Cure Superposition method.

- **6 simultaneous measurements**
- **From RT to 90°C**
- **Time Cure Superposition treatment for accurate gel point determination**
- **I\* to monitor macroscopic evolution (size or concentration)**



RHEOLOGY ON CHIP

# VISCOSITY WITH EYES WIDE OPEN



# RHEOLOGY ON CHIP

## OPTICAL MEASUREMENT OF CONFINED FLOW RHEOLOGY



### MEASUREMENT PRINCIPLE

A sample and a viscosity standard are pushed together through a « Y-shaped » microfluidic chip at controlled flow rates. Images of the resulting laminar co-flow are acquired via an integrated optical system and the position of the interface is measured. The interface position is related to the viscosity and the flow rate ratios between the sample and the reference. Using dedicated algorithms, sample viscosity is automatically extracted as a function of shear rate and temperature.

### FLOW CURVE IN A SINGLE CLICK

Viscosity measurement is now as easy as filling a syringe. Once shear rate ranges and temperatures are selected, software will automatically control and adjust the flow rate and determine the viscosity. Not only it enables one-click experiments, but the technology is also calibration free and extremely precise.

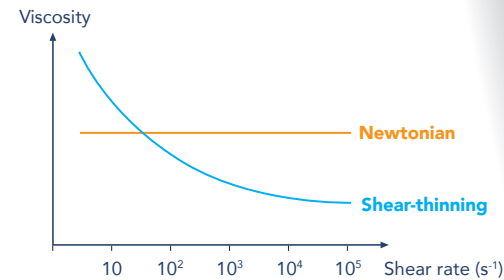

### VISUAL RHEOLOGY

Based on a simple intuitive principle, the interface between the fluids is detected by a video camera.

Each measurement point is associated to an image accessible for control during and after the analysis. Thanks to Fluidicam, reliability reaches a new standard.

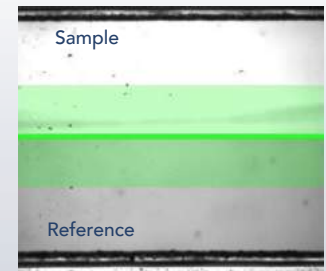

### VISUAL FLOW RHEOLOGY BY MICROFLUIDICS

Fluidicam is designed for flow curve measurements over a wide range of application: from extremely low viscosity up to thick and pasty formulations. Thanks to its unique microfluidic technology, Fluidicam covers a very wide range of shear rates (even higher than  $10^5 s^{-1}$ ) with low sample consumption.

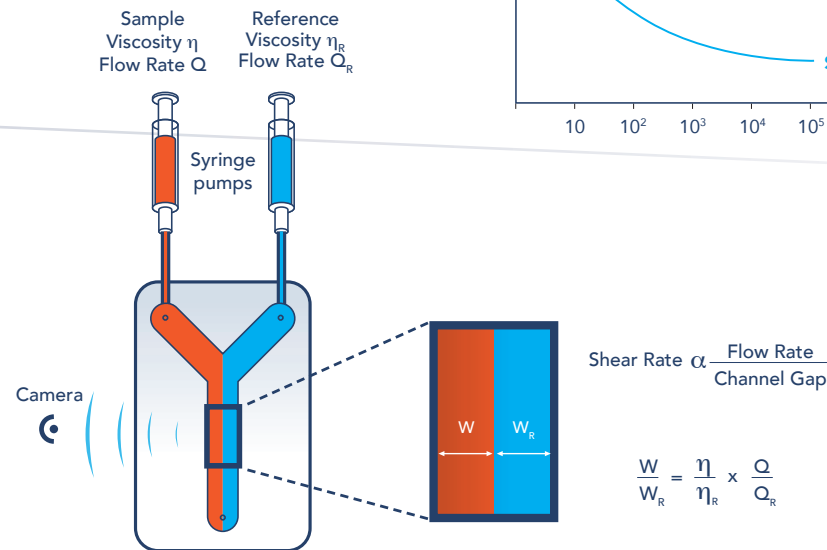

**PHARMACEUTICALS**

- Injectability: measure viscosity of vaccine and other solutions at high shear rates.
- Protein denaturation/aggregation: high sensibility measurement to monitor slight variation in the viscosity and detect the protein unfolding and/or aggregation with very small sample volume
- QC control: fast, easy, robust viscosity measurement

**INK**

- High shear rates measurement to understand the ink behavior when going through the printing head. Closed configuration prevents evaporation

**HOME & PERSONAL CARE**

- Mimicking cosmetic spreading: body lotion, facial cream, nail varnish, mascara, foundation...

**POLYMER**

- Molecular weight determination : Thanks to its high sensibility, intrinsic viscosity can be determined

**OIL & PETROLEUM**

- Enhance oil recovery : simulate the polymer solution in the oil reservoir
- Drilling fluids : Ensure the lubricating and suspending properties of the drilling fluids under strong confinement

**ELECTRONICS**

- Viscosity measurement on fuel cell and battery, electronic inks, screen coating... have never been that easy and accurate

**FOOD**

- Soft Drinks and dairy drink: hassle free and precise viscosity measurement
- Spray drying: Understanding the liquid behavior at high shear rates

**OTHERS**

- Lubricating oil, paper coating, speciality chemicals, biopolymer, thickener...

**BENEFITS****VERSATILE**

Wide range of shear rates (higher than  $10^5 \text{ s}^{-1}$ ) and wide range of viscosity: 0.1-200,000 cP

**VISUAL CONTROL**

Enhance reliability

**STRAIGHT FORWARD**

One click experiment, fast, automated shear rate and temperature screening

**AND MUCH MORE...**

High precision even at very low viscosity, automatic flow control, Disposable microfluidic chip...

## FLUIDICAM: VISUAL FLOW RHEOLOGY BY MICROFLUIDICS

FLUIDICAM has been designed for precise viscosity measurements of a wide range of products. Small chip dimensions and direct flow control enable to access high shear rates with less than a milliliter of sample.

This ready to use instrument gives access to a flow curve in a single click with no calibration, geometries or sensors in the chip, making the rheology measurement cost-effective and time-saving.

Furthermore, viewing experiment images in real-time gives additional insight about the progress of the analysis, while storing these images afterwards gives additional reliability to the results.

### MAIN ADVANTAGES

- Wide viscosity range: from low viscosity up to pasty/thick samples
- Extreme precision, even at low viscosity
- High shear rate: from 100 to more than  $10^5 \text{ s}^{-1}$
- Small Sample volume:  $<500 \mu\text{L}$
- Easily disposable chips
- Measurement at Flow: always measure on a fresh sample
- Fast temperature screening from 4 to  $80^\circ\text{C}$



## FLUIDICAM<sup>RHEO</sup>

RHEOLOGY ON CHIP

### Flow curve in the blink of an eye

One of a kind, fully automated rheometer combining microfluidic and imaging technologies. Easily plot flow curve as a function of shear rate and temperature with high precision and repeatability.

- Shear rate: 100 to more than  $10^5 \text{ s}^{-1}$
- Temperature: 4 to  $80^\circ\text{C}$
- Viscosity: 0.1 to 200,000 cP

|   | TURBISCAN CLASSIC2<br><small>STABILITY &amp; SIZE</small>   | TURBISCAN LAB<br><small>STABILITY &amp; SIZE</small> | TURBISCAN TOWER<br><small>STABILITY &amp; SIZE</small> | TURBISCAN AGS<br><small>STABILITY &amp; SIZE</small> |
|---|---|--|--|--|
| Emission (Light Source)                         | 850nm   | 880nm  | 880nm  | 880nm  |
| Detection                                       | MLS   | MLS  | MLS  | MLS  |
| Cell Volume                                     | 7ml   | 4 or 20ml  | 4 or 20ml  | 20ml   |
| Quantitative monitoring of dispersion stability | •   | •  | •  | •  |
| Migration velocity & hydrodynamic diameter      | •   | •  | •  | •  |
| ISO TR 13097 Compliant                          | •   | •  | •  | •  |
| ASTM D-7061 Compliant                           | •   | •  | •  | •  |
| Oil Series                                      | Oil Series  | •  | •  | •  |
| Disposable glass cells                          |   | •  | •  | •  |
| Turbiscan Stability Index (TSI) computation     |   | •  | •  | •  |
| Automatic reporting                             |   | •  | •  | •  |
| Automatic samples recognition (bar-code)        |   | •  | •  | •  |
| Temperature control                             |   | RT+5°C to 60°C                                       | 4 to 80°C  | RT+5°C to 60°C                                       |
| Mean diameter and volume fraction               |   | •  | •  | •  |
| Multi-samples                                   |   |  | 6  | 54   |
| Storage at 3 different temperatures             |   |  |  | •  |
| Dimensions (cm)                                 | 27.5x13x23.5  | 38x42x32   | 35x45x90   | 145x75x85  |
| Weight (kg)                                     | 5   | 13   | 45   | 50   |
| Recommended PC configuration                    | Intel Dual Core @ 2.5Ghz or AMD X2 processor / 4Gb RAM, USB / Microsoft Windows XP or newer, 32/64 bits |  |  |  |

|                              | FLUIDICAM RHEO<br><small>RHEOLOGY ON CHIP</small>   | RHEOLASER COATING<br><small>MICRORHEOLOGY</small> | RHEOLASER MASTER<br><small>MICRORHEOLOGY</small>                                 | RHEOLASER CRYSTAL<br><small>MICRORHEOLOGY</small>                                   |
|------------------------------|---|---|--|---|
| Microchip                    | 150 or 50 microns, glass or PMMA  | Emission (Light source)                           | 650nm or 850nm   | 650nm   |
| Syringe size                 | 10 or 1 ml  | Detection   | MS-DWS   | MS-DWS  |
| Minimum sample volume*       | 100µl   | Cell Volume                                       |  | 4 or 20ml   |
| Temperature range            | 4 to 80°C   | Storage positions                                 |  | 6   |
| Accuracy                     | 1%  | Simultaneous measurements                         | 1 to 4   | 6   |
| Repeatability                | 1%  | Temperature range                                 |  | RT+5°C to 90°C  |
| Dimensions (cm)              | 66x35x28  | I* measurement                                    |  | •   |
| Weight (kg)                  | 20  | Minimum viscosity (cP)                            |  | 15  |
| Recommended PC configuration | Intel Dual Core @ 2.5Ghz / 2Gb RAM, 50Gb Hard Drive space, USB / Microsoft Windows 7 or newer, 32/64 bits | Dimensions (cm)                                   | 70x60x62   | 60x40x30  |
|                              |   | Weight (kg)                                       | 45   | 36  |
|                              |   | Recommended PC configuration                      | Intel Dual Core @ 2.5Ghz / 2Gb RAM, USB / Microsoft Windows XP or newer, 32 bits | Intel Dual Core @ 2.5Ghz / 4Gb RAM, USB / Microsoft Windows XP or newer, 32/64 bits |
|                              |   |   |  | 30x40x40  |
|                              |   |   |  | 10  |

\*for 1 measurement point